

5. Push the SCOUT IX-3 blaster forward to cock the UNITY POWER SYSTEM.

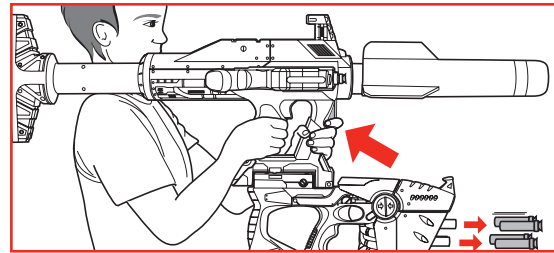

6. Pull the HORNET AS-6 Trigger to launch all 6 of the MICRO DARTS.

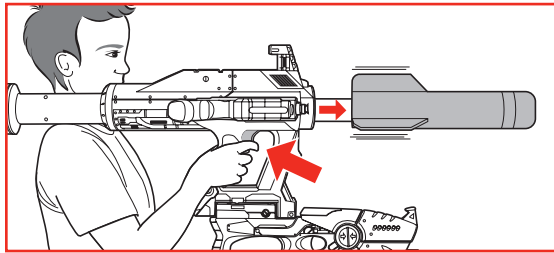

7. Pull the TITAN AS-V.1 Trigger to launch the MEGA MISSILE.

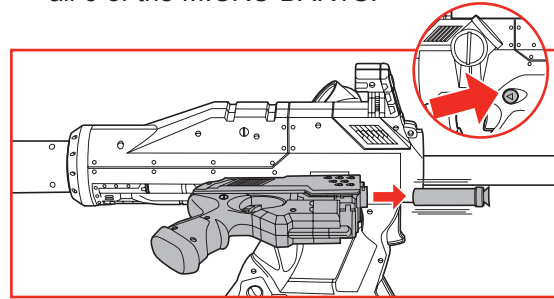

8. Push the SCOUT IX-3 Launch Button to launch the SCOUT IX-3 MICRO DART.

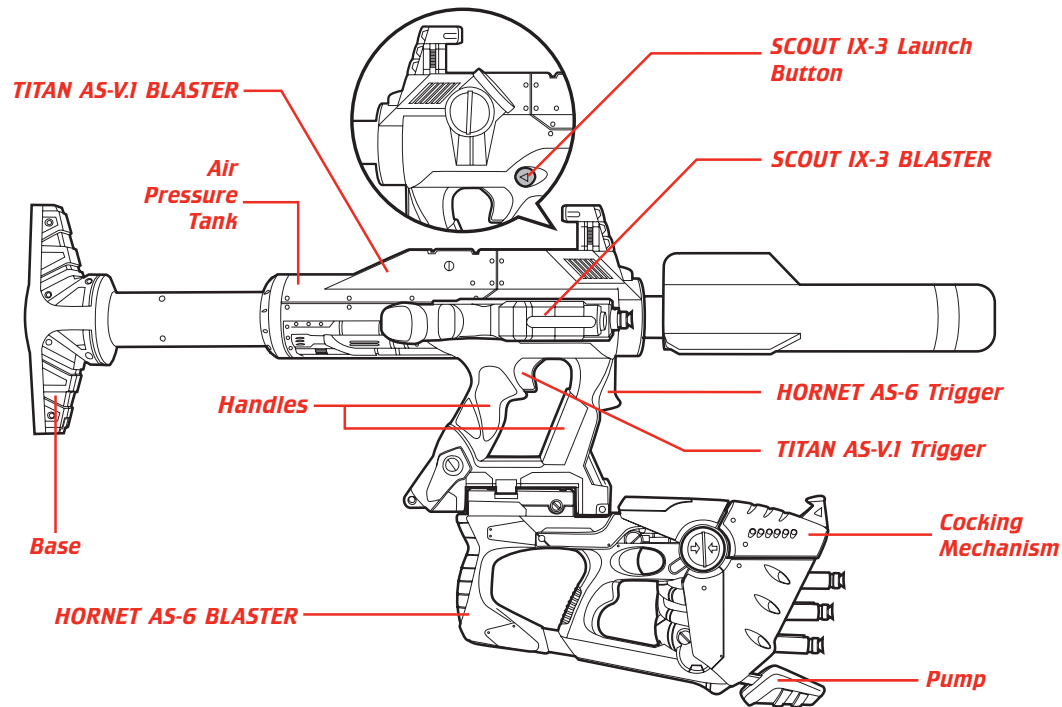

AGES 8+



**N-STRIKE™**

62659

Thank you for purchasing the NERF N-STRIKE 3-in-1 blaster. Be sure to read and follow all instructions carefully before using this product.

Use all 3 blasters separately or snap them together to create the UNITY POWER SYSTEM™.

**CAUTION:** Do not aim at eyes or face.  
**TO AVOID INJURY:** Use only missiles designed for this product. Do not modify missile or missile launcher.

**TITAN AS-V.I™ BLASTER WITH THE MEGA MISSILE™**

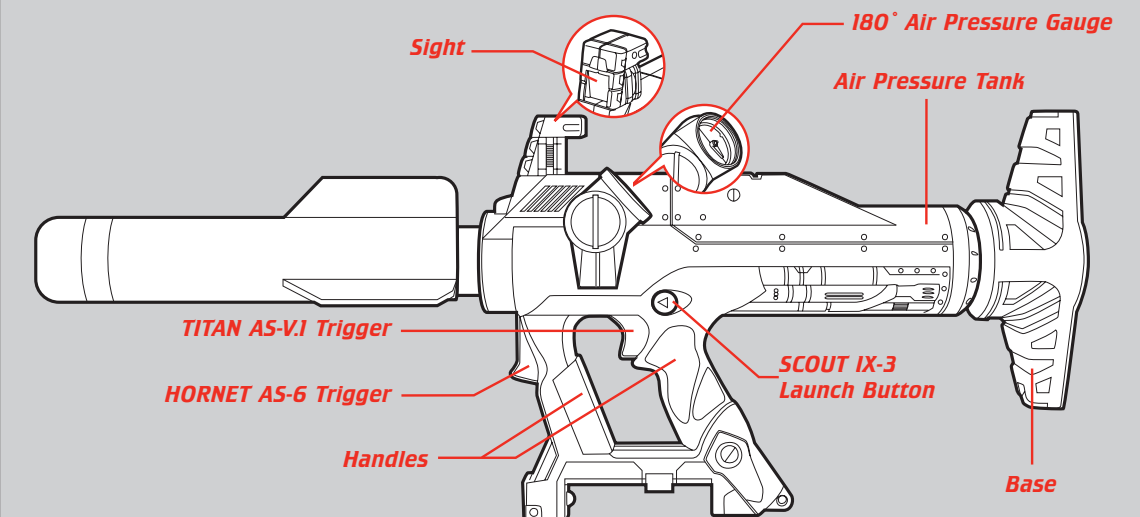

Hasbro  
 © 2006 Hasbro. All Rights Reserved.  
 TM and © denote U.S. Trademarks  
 U.S. Patent No. 5,529,050 & Patents Pending.  
 62659 PN 6576430000

Product and colors may vary.

Visit  
 Hasbro.com NERF.com  
 Questions? Call: 1-800-327-8264

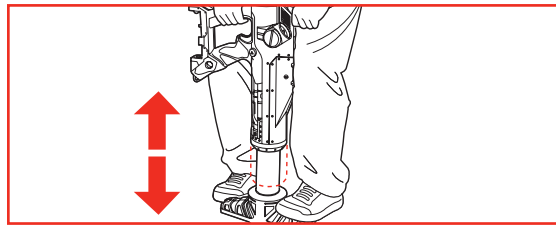

1. Place your two feet on the Base, and use the Handles to Pump the TITAN AS-V.1 blaster approximately 16 times.

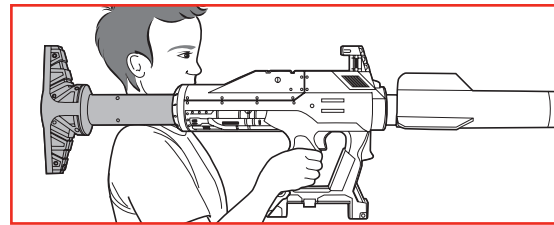

2. Extend the Base/Air Pressure Tank portion over your shoulder.

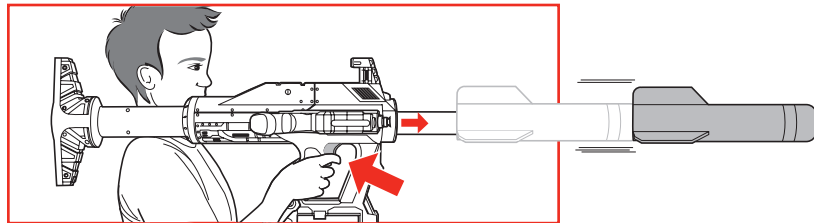

3. Pull the TITAN AS-V.1 Trigger fast to let the MEGA MISSILE soar!

**NOTE:** To launch the MEGA MISSILE out of the TITAN AS-V.1 blaster, hold it at a 45° angle or lower, or it will not launch. Never launch the MEGA MISSILE at TV.

### HORNET AS-6™ BLASTER WITH 6 MICRO DARTS™

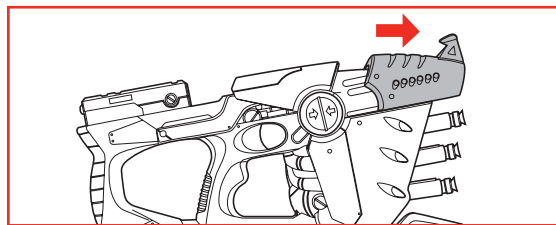
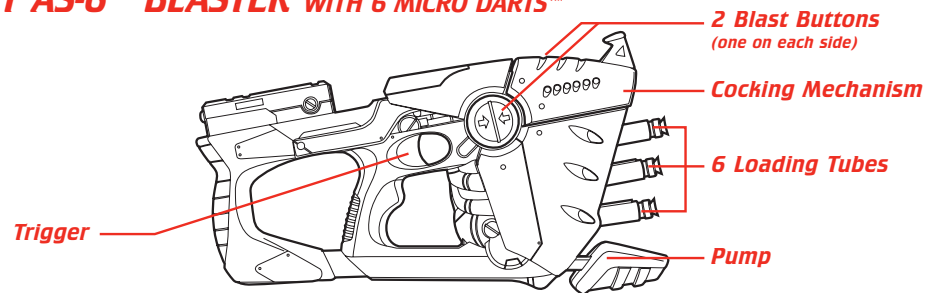

1. Slide the Cocking Mechanism forward, then back to its original position.

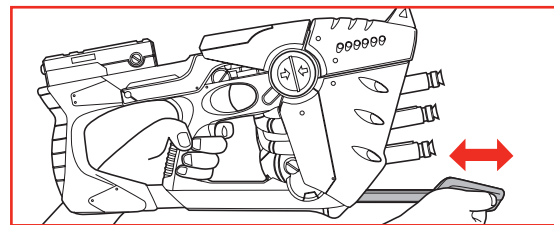

2. Pump the HORNET AS-6 blaster 20 times to pressurize.

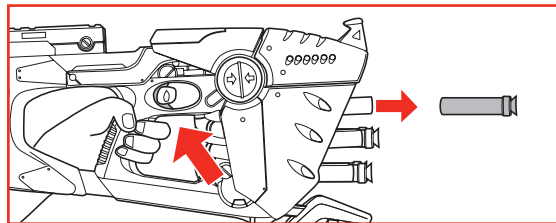

3. Pull the Trigger to launch 1 MICRO DART.

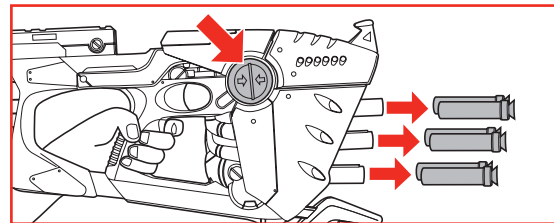

4. Push 1 or both of the Blast Buttons to launch all 6 MICRO DARTS at once.

### SCOUT IX-3™ BLASTER WITH 3 MICRO DARTS™

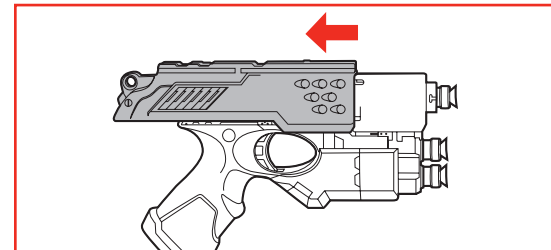
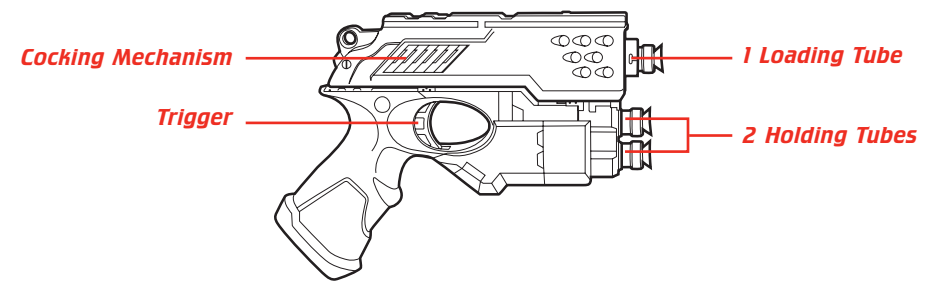

1. Slide the Cocking Mechanism backwards.

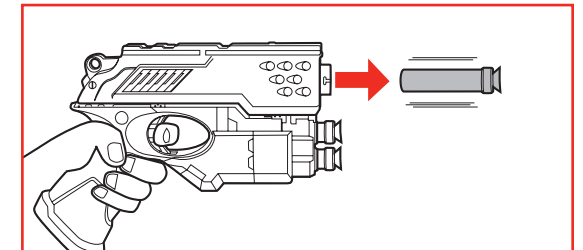

2. Pull the Trigger to launch 1 MICRO DART.  
3. Refill the Loading Tube from the 2 Holding Tubes as necessary.

### UNITY POWER SYSTEM™ TO ASSEMBLE:

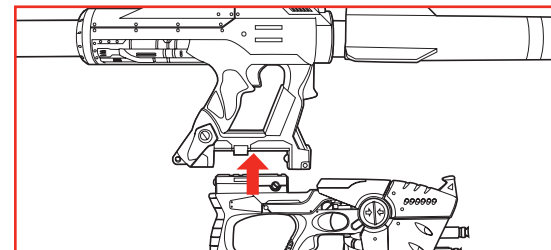

1. Push/snap HORNET AS-6 blaster onto TITAN AS-V.1 blaster. Slide the Cocking Mechanism forward.

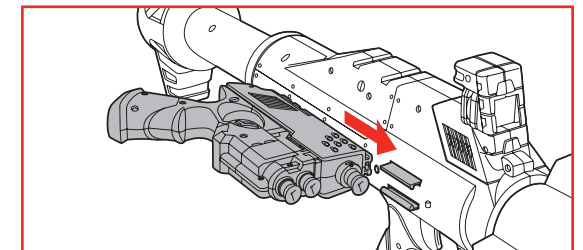

2. Slide/snap SCOUT IX-3 blaster onto TITAN AS-V.1 blaster. Lock into place.

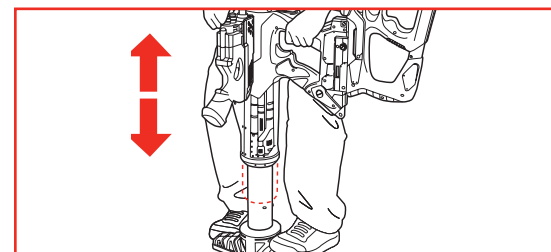

3. Place your two feet on the Base of the TITAN AS-V.1 blaster, and use the Handles to Pump the UNITY POWER SYSTEM 18-20 times.

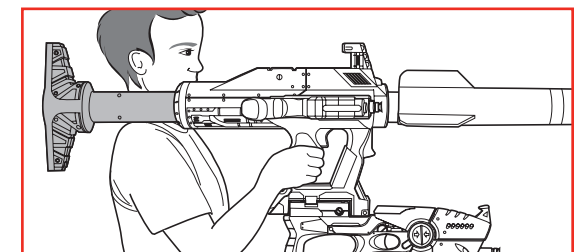

4. Extend the Base/Air Pressure Tank portion of the TITAN AS-V.1 blaster over your shoulder.